

Detalhes de Engenharia

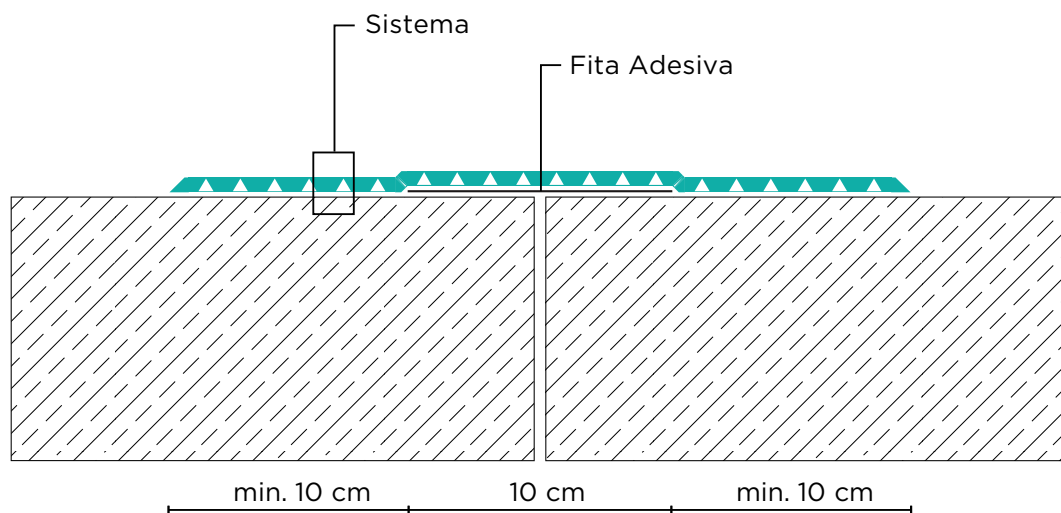

Trincas e juntas estabilizadas

Composição do sistema

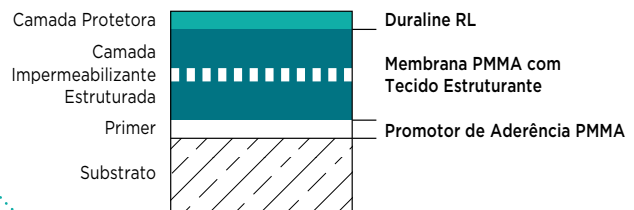

Detalhes de Engenharia



Juntas de construção

Composição do sistema

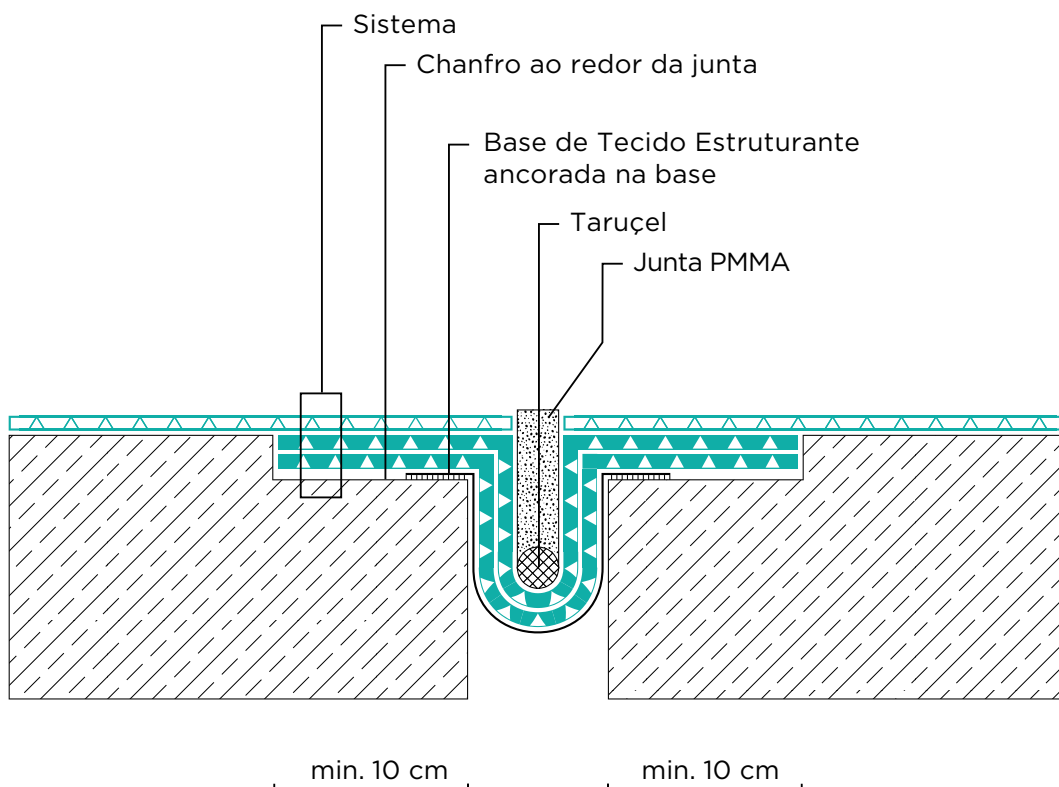
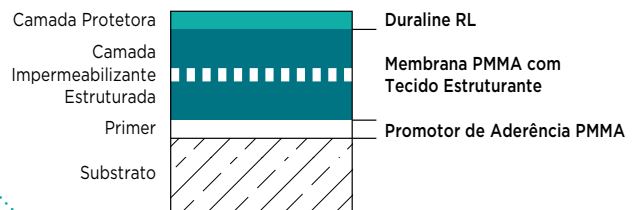

Detalhes de Engenharia



Junta de encontro

Composição do sistema

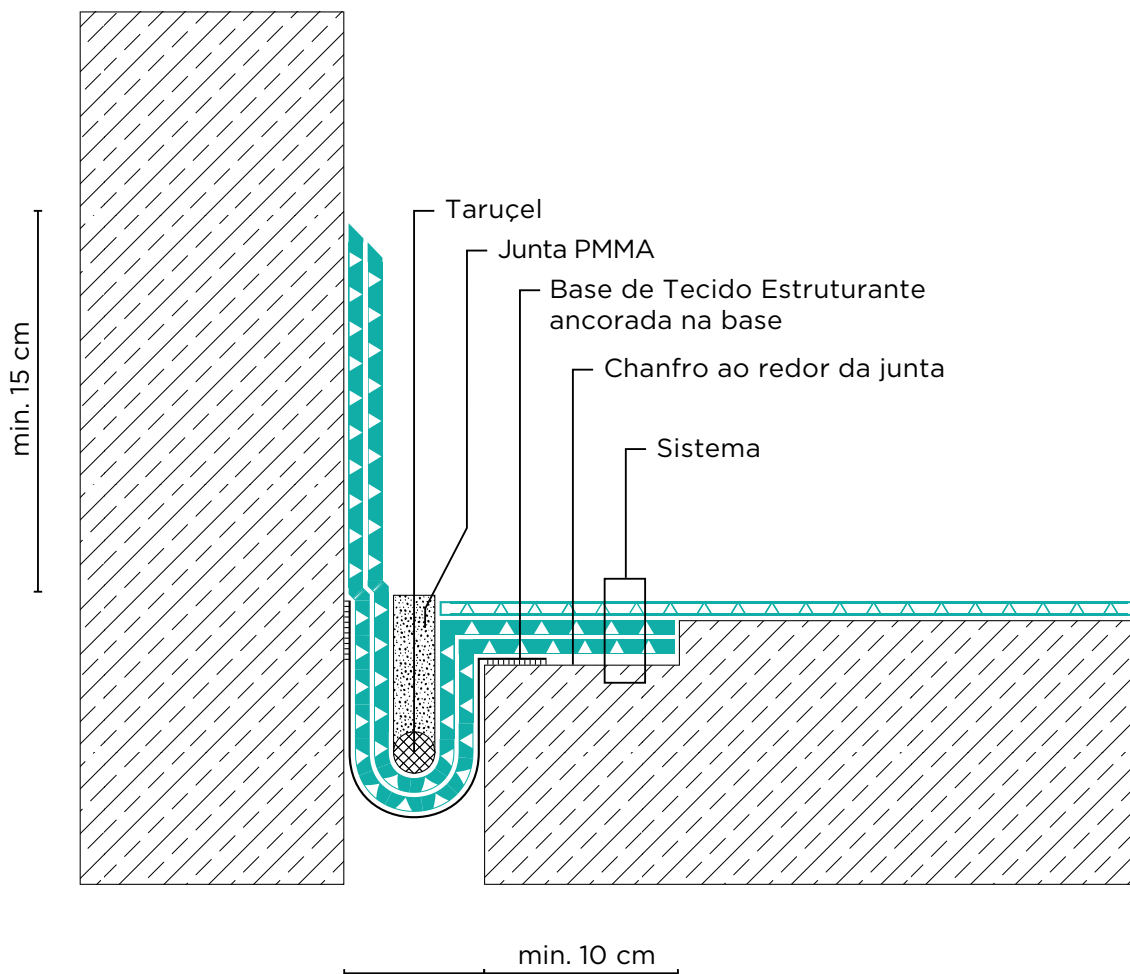
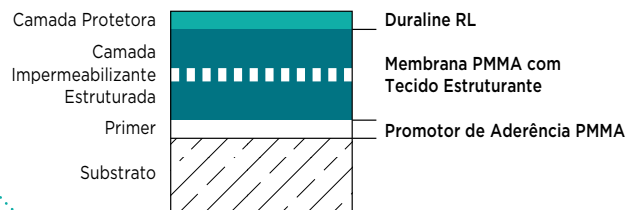

Detalhes de Engenharia



Canaletas metálicas

Composição do sistema

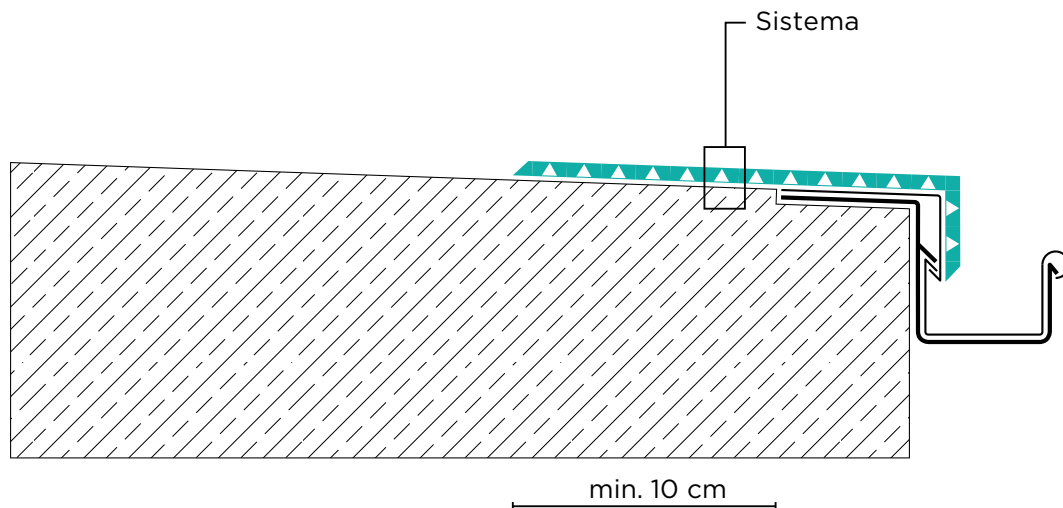
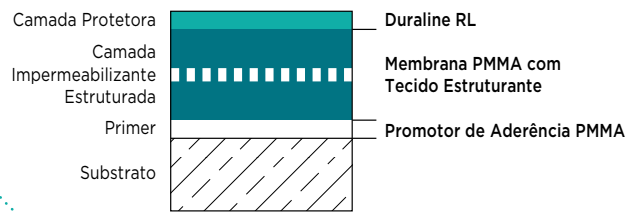

Detalhes de Engenharia



Ralos e grelhas

Composição do sistema

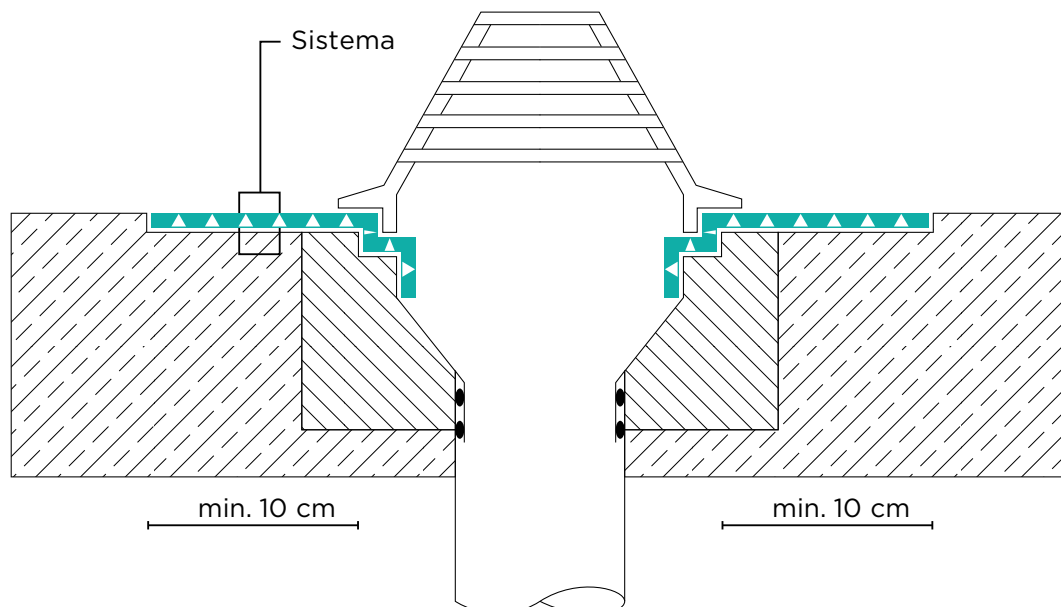
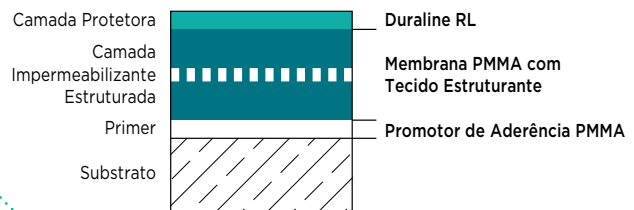

Detalhes de Engenharia



Parapeitos com rufos metálicos

Composição do sistema

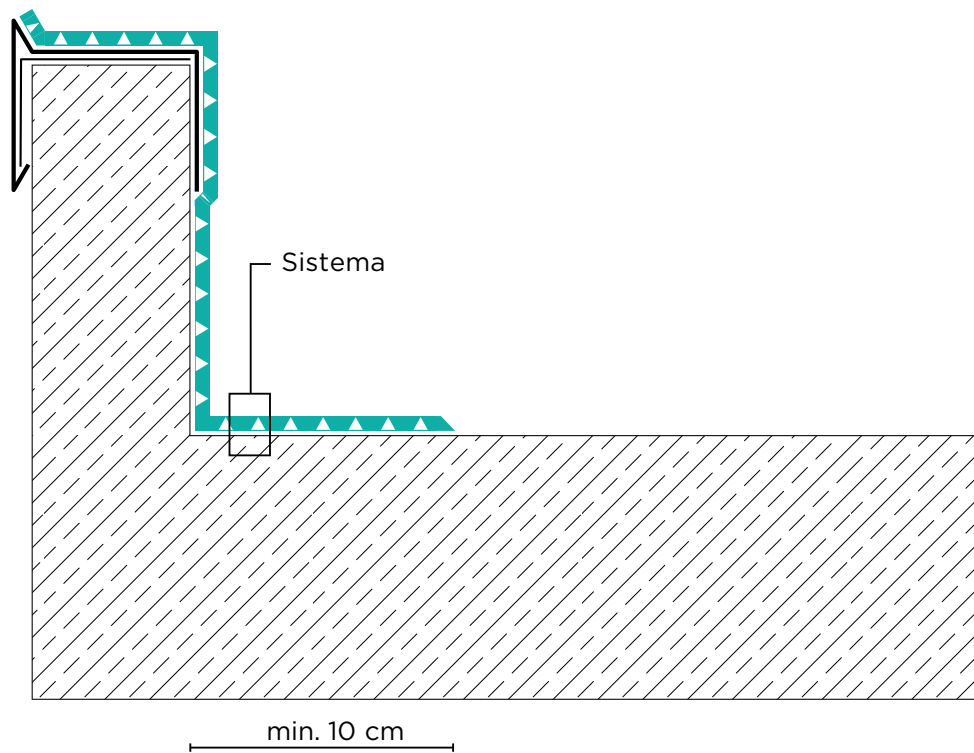
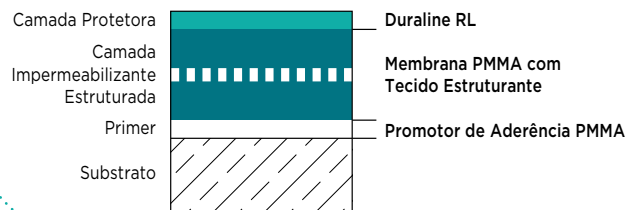

Detalhes de Engenharia



Rodapés e quinas

Composição do sistema

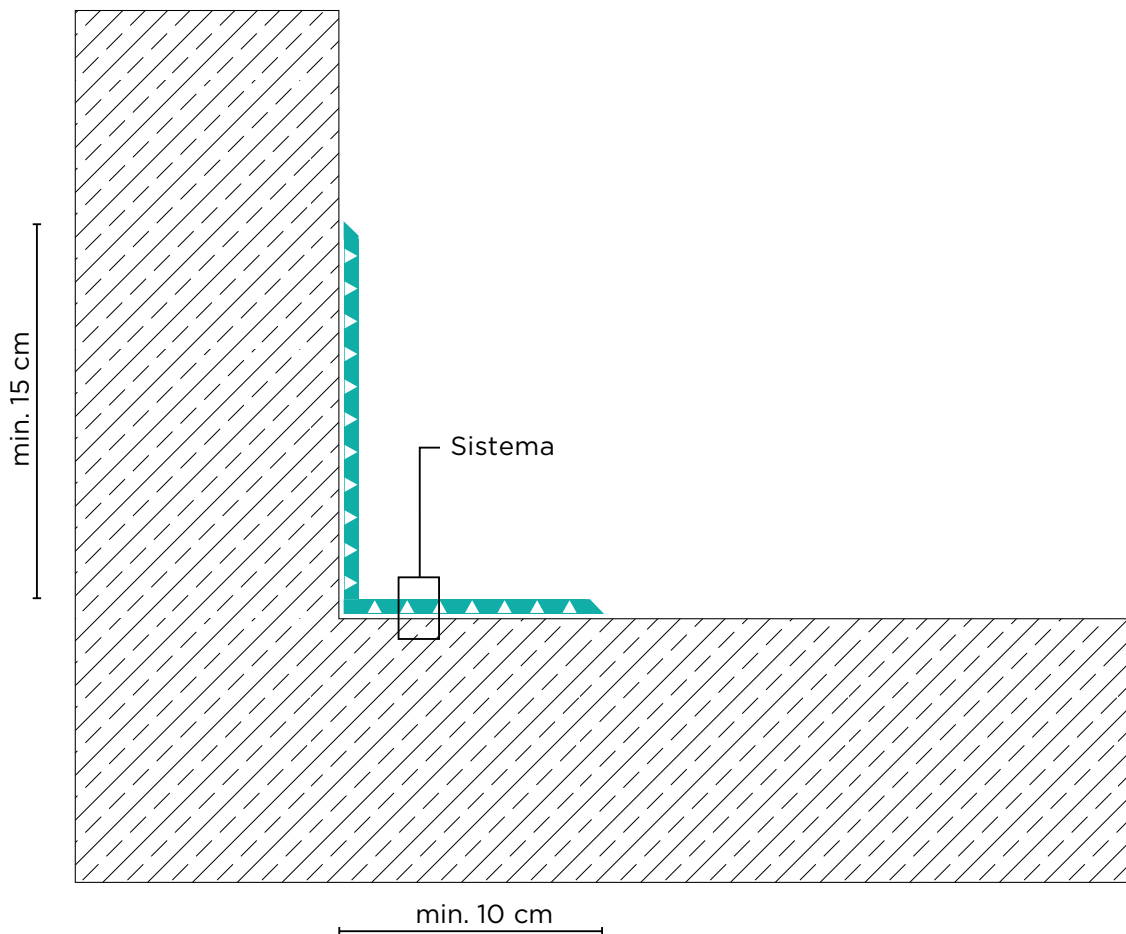
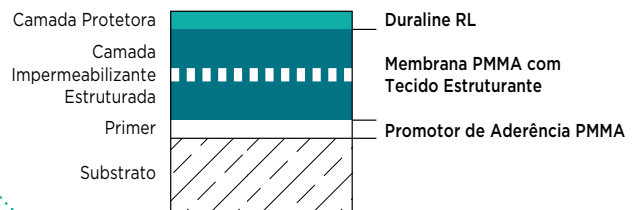

Detalhes de Engenharia



Encanamento emergente

Composição do sistema

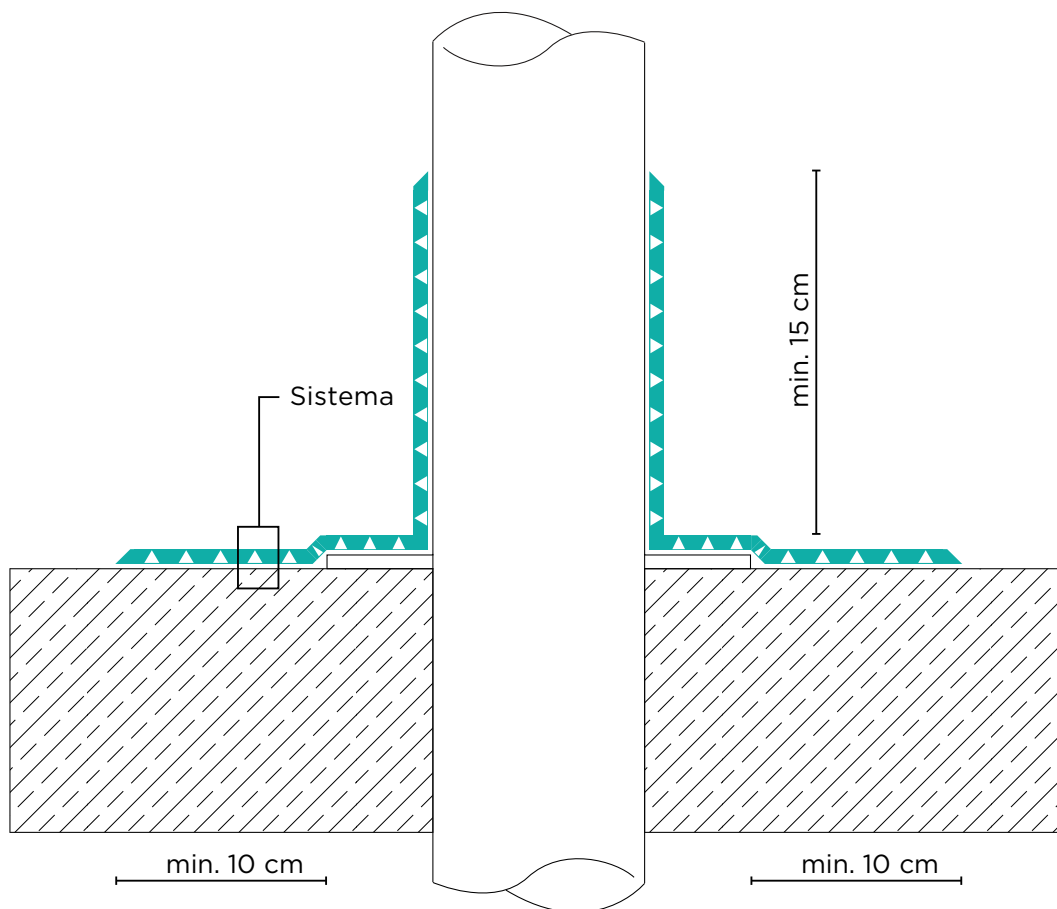
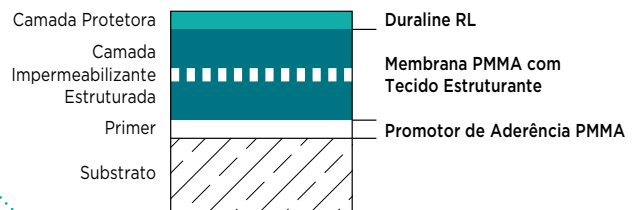

Detalhes de Engenharia



Integração com manta asfáltica
e outros sistemas de impermeabilização

Composição do sistema

